



AENSI Journals

Australian Journal of Basic and Applied Sciences

Journal home page: www.ajbasweb.com



Generalised Approach to the Analysis of Asymmetrical Delta Connected Three-Phase Induction Motor

¹Jafar H.H. Alwash, ²Salman H. Ikhwan, ³Ruba M.K. AL-Mula Humadi

¹Electrical Engineering Department, College of Engineering, Baghdad University, Baghdad, Iraq.

²Electrical Engineering Department, College of Engineering, Baghdad University, Baghdad, Iraq.

³Mechanical Engineering Department, College of Engineering, Baghdad University, Baghdad, Iraq.

ARTICLE INFO

Article history:

Received 23 September 2013

Received in revised form 18

November 2013

Accepted 20 November 2013

Available online 4 December 2013

Keywords:

Induction Motor, Symmetrical Component Theory, Asymmetrical Windings.

ABSTRACT

Background: Induction motors are the commonly used machines in industrial applications as well as in our live such as in washing machines, and fans. These motors are available in two types; three-phase and single-phase. The stator windings may be symmetrical or asymmetrical, this paper deals with asymmetrical ones. The procedure of asymmetry is made by removing a part from phase B and then adds it to phase C, while phase is kept unchanged. **Objective:** Presenting a general method to predict the performance of a delta connected induction motors having asymmetrical stator windings. **Results:** The theoretical results are validated with the experimental models. And an investigation of the possible existence of zero-sequence currents is presented together with the ways to minimize their effects. **Conclusion:** The machine parameters are calculated using classical method. The program is also applicable with some modifications and changes to some of its equations if another type of slots is used.

© 2013 AENSI Publisher All rights reserved.

Nomenclature:

a	e^{j120}
A_r	rotor surface area; m^2
A_s	stator surface area; m^2
f	frequency; H_z .
I	r.m.s current; A
I_A, I_B, I_C	stator line currents; A
I_{AB}, I_{BC}, I_{CA}	stator phase currents; A
I_0	zero-sequence current; A
$[I_{ph}]$	actual phase current array matrix; A
$[IW]$	complex effective r.m.s. phase current matrix; A
J_s, J_r	line current density for stator and rotor respectively; A/m.
\hat{J}_1, \hat{J}_2	peak value of the respective quantities, A/m
L_2	$=L_{22}+L_{2g}$
L_{22}	surface mutual inductance between stator and rotor; H
L_{2g}	rotor surface leakage inductance; H
n	pole pair harmonic order.
R	Stator radius; m.
$\Re(\)$	real value of the quantity enclosed in the brackets.
s	slip.
$[S]$	complex effective conductor number matrix.
t	time; sec.
T	output torque; N.m.
U_{sn}	synchronous speed; m/sec
V	supply voltage; V
$[v]$	voltage array matrix for machine equivalent circuit.
V_{mA}, V_{mB}, V_{mC}	stator induced phase voltage for phases A, B and C; V.
X_1	stator circumferential length in mechanical radians.
X_2	rotor circumferential length in mechanical radians.
X_a	angle displacement between the slots in mechanical radians.
ρ_2	rotor surface resistivity; Ω
ω	$2\pi f$.
$\hat{J}_{1n}, \hat{J}_{2n}, L_{22n}, L_{2gn}, L_{2n}, S_n, \rho_{2n}$	the value of the respective quantities for the n^{th} harmonic.

INTRODUCTION

The unbalanced operation of a three-phase induction machine has been the subject of considerable interest over the years (Al-MulaHumadi, 2001)-(Wang, 2000), and several attempts have been made by many authors to develop a generalised approach to the solution of problems connected with such operations.

There are three methods used to analyze electrical machines: The first method (Brown and Butler, 1953), (Brown and Jha, 1962), (Butler and Wallace, 1968), (Jha and Murthy, 1973), (Guru,1979, Revolving), (Guru, 1979, Cross) and (Guru, 1981) is based on viewing the machine from outside, as an electrical network having self and the mutual parameters. The second method (Battersby,1965), (Stepina, 1968) and (Stepina, 1979) is the classical method, which is based on viewing the machine from inside starting with the air-gap fields. The third method (Alwash and Ikhwan,1995), (Ikhwan, 1991) and (Al-MulaHumadi, 2001)is a combination of the two methods.

Most authors (Brown and Butler, 1953), (Brown and Jha, 1962), (Butler and Wallace, 1968), (Jha and Murthy, 1973), (Guru,1979, Revolving), (Guru, 1979, Cross) and (Guru, 1981)based their analysis on the first method to derive an equivalent circuit, from which the machine performance may be calculated. It should be noted that the circuit parameters were mostly found to be difficult, complicated and applicable only for a special type of asymmetry in the machine (Brown and Butler, 1953) and (Brown and Jha, 1962).Therefore using the second method to analyze the asymmetrical machines is more convenient, especially for machines having different slot shapes, irregular displacement between the slots and irregular air-gaps (Battersby,1965), (Stepina, 1968) and (Stepina, 1979). While using the third method the analysis will be very easy.

Various other authors (Pillay *et al.*, 2002), (Faiz *et al.*, 2004) and (Wang, 2000) have concentrated their works on the problem of feeding three-phase induction motor with symmetrical windings from unbalanced supply.

It is the object of this paper to follow the general method presented by the author in a previous paper (Alwash and Ikhwan, 1995) which dealt with three wire star connected induction motors with the required modifications so as to apply it for the prediction of the performance of Delta connected induction motors. Further the paper presents an investigation of the existence of Zero-sequence e.m.fs and currents, and the possible practical ways to minimize their effects on the performance.

It should however be appreciated that the method presented may easily be used to predict the performance of the motor fed from unbalanced three-phase supply.

Mathematical Model:

A three-phase squirrel-cage induction motor has been chosen for the analysis. It is assumed that the air-gap is uniform and the stator has identical slot shapes.

Expressions for stator current sheet and rotor current sheet were formulated (Alwash and Ikhwan, 1995) as matrices taking into account harmonic effect. Stator induced phase voltages can be found by making use of symmetrical component theory. Then an equivalent circuit is obtained, by applying Kirchhoff's laws, phase current can be obtained, line currents are calculated. Finally, output torque is obtained for any speed from standstill up to synchronous speed.

Mathematical Analysis:

A. Stator, Rotor Current Sheets And Equivalent Machine Impedance Referred To Stator Current Sheet:

As it was assumed that the stator has identical slot shapes, it is enough to derive the stator current sheet by taking one slot and then add the partial effects of individual slots. By considering one conductor per slot at the beginning, the current per slot opening width for a slot is symmetrical and periodic, so it can be analyzed by using Fourier series. The mean value of Fourier series will be zero because, whenever a conductor carrying current is found in slot m1, there must be another conductor in slot m2, carrying the same current but in opposite direction.

Now, since the analysis have been derived on the basis of having positive slot current, a unit vector z_{mM} (Appendix) would be used. Also, the effects of all conductors per slot would be taken into account. After a few simplifications the equation for stator current sheet in matrix form would be:

$$J_s = \sum_{\substack{n=-\infty \\ n \neq 0}}^{n=\infty} J_{1n} = \sum_{\substack{n=-\infty \\ n \neq 0}}^{n=\infty} \hat{J}_{1n} \Re[e^{j(\omega t - nX_1 - a_n)}] \quad (1)$$

Where:

$$\hat{J}_{1n} = \frac{1}{\sqrt{2}R\pi} |[S_n][IW]| \quad (2)$$

Since the rotor is short circuited, a current will flow in the rotor and may be represented as surface current sheet J_r given as:

$$J_r = \sum_{\substack{n=-\infty \\ n \neq 0}}^{n=\infty} J_{2n} = \sum_{\substack{n=-\infty \\ n \neq 0}}^{n=\infty} \hat{J}_{2n} \Re[e^{j(S_n \omega t - nX_2 - \theta_n)}] \quad (3)$$

Then, a rotor voltage equation will be derived (Alwash and Ikhwan, 1995) from which the rotor current sheet could be calculated:

$$\hat{J}_{2n} e^{j(\theta_n - a_n)} = \frac{-jS_n \omega L_{22n} \hat{I}_{1n}}{\rho_{2n} + jS_n \omega L_{2n}} \quad (4)$$

An equivalent machine phase impedance for the case of balanced stator currents referred to stator current sheet may be given as (Pillay *et al*, 2002)

$$Z_2 = \frac{A_s}{6I^2} \sum_{\substack{n=-\infty \\ n \neq 0}}^{n=\infty} \left[(\hat{J}_{2n})^2 \frac{j\omega L_{22n} (\rho_{2n} + jS_n \omega L_{2gn})}{\rho_{2n} + jS_n \omega L_{2n}} \right] \quad (5)$$

B. Stator Induced Phase Voltages:

An asymmetrical three-phase machine will draw unbalanced currents if it is connected to a balance voltage source. These currents can be analyzed using symmetrical component theory into three symmetrical component currents; positive, negative and zero-sequence currents. Since the machine was Delta connected, no one of the mentioned component shall be ignored.

Now the response of the machine to positive sequence current I_f may be represented by:

$$I_f Z_{ff} = V_{ff} \quad (6)$$

$$I_f Z_{bf} = V_{bf} \quad (7)$$

Where Z_{ff} and Z_{bf} are the machine impedances referred to the stator current sheet with the rotor moving in the forward and backward direction, respectively. The response of the machine to negative sequence current I_b may be represented by

$$I_b Z_{fb} = V_{fb} \quad (8)$$

$$I_b Z_{bb} = V_{bb} \quad (9)$$

Since the machine will behave, when rotating in the direction of the field, in the same manner, irrespective of the field being due to the positive or negative sequence currents.

$$Z_{fb} = Z_{ff} = Z_f \quad (10)$$

$$Z_{bf} = Z_{bb} = Z_b \quad (11)$$

Z_f and Z_b may be found from (5) using, for each harmonic, slip s_n and s_{bn} , respectively.

When $s_{bn} = 2 - s_n$.

Finally, the response for zero-sequence current may be represented as:

$$I_0 Z_0 = V_0 \quad (12)$$

Z_0 may be found from (5) when the machine is fed with zero-sequence current.

C. Phase Currents:

The equivalent circuit for a Delta connected machine fed from three phase-balanced supply may be set as shown in Fig. 1. Applying Kirchhoff's law Fig. 2 gives:

$$V - V_{mA} - a^2 V = I_{AB} \cdot Z_{LA} \quad (13)$$

$$V + V_{mC} - aV = -I_{CA} \cdot Z_{LC} \tag{14}$$

$$a^2V - V_{mB} - aV = I_{BC} \cdot Z_{LB} \tag{15}$$

These equations may be set into a single matrix equation from which phase currents $[I_{ph}]$ are easily calculated.

$$[ZZ][I_{ph}] = [v] \tag{16}$$

$$[I_{ph}] = [ZZ]^{-1} \cdot [v] \tag{17}$$

Applying Kirchoff's current law to Fig. 2 the line currents may be obtained:

$$I_A = I_{AB} - I_{CA} \tag{18}$$

$$I_B = I_{BC} - I_{AB} \tag{19}$$

$$I_C = I_{CA} - I_{BC} \tag{20}$$

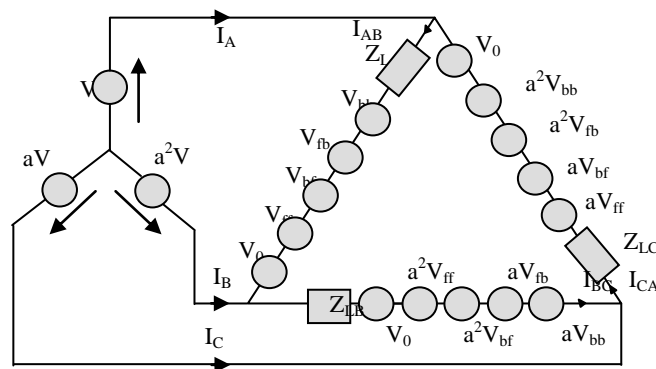

Fig. 1: Equivalent circuit diagram

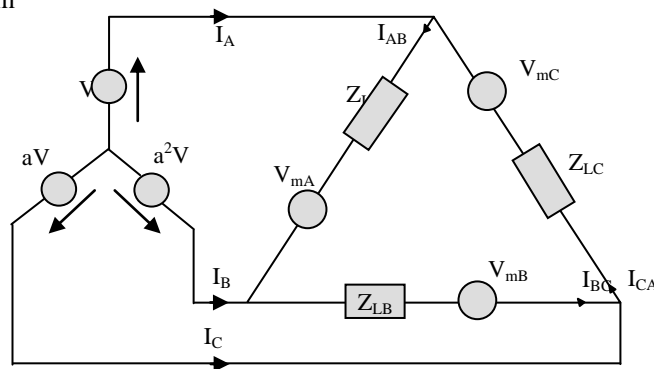

Fig. 2: Simplified equivalent circuit diagram

E. Output Torque:

Using the complex effective r.m.s. currents matrix $[I_{ph}]$ as the actual phase currents, the nth harmonic actual stator current sheet is found in the manner represented by (1). The nth harmonic actual rotor current sheet is obtained from (3) and (4). Therefore the output torque can be calculated in Newton-meters from the following equation:

$$T = \frac{RA_r}{2} \sum_{\substack{n=-\infty \\ n \neq 0}}^{n=\infty} \frac{\rho_{2n} (\hat{J}_{2n})^2}{U_{Sn} S_n} \tag{21}$$

Experimental Model:

Two models (A and B) were used for the experimental test. The machines data were tabulated in Table I.

Table I: Machine Data

Symbol	Model A	Model B
P: number of poles.	4	4
S ₁ : number of stator slots.	36	36
S ₂ : number of rotor slots.	42	33
Type of windings.	Double layer	Double layer
Number of coils/pole/phase.	3 coils	3 coils
Number of turn /coil.	50 turns	50 turns
Pole pitch.	9 slots	9 slots
Coil pitch.	6 slots	7 slots
Chording	3 slots	2 slots

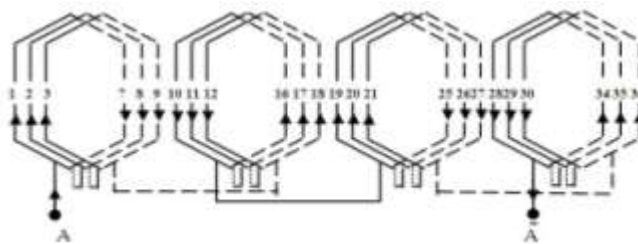

Fig. 3: Phase A winding diagram Model A

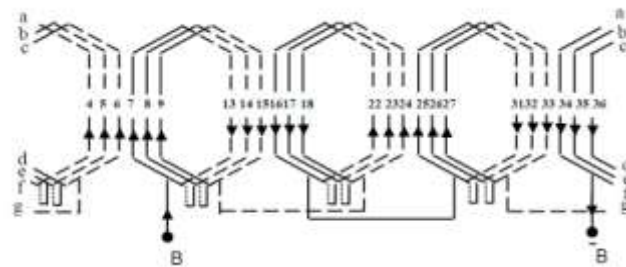

Fig. 4: Phase B winding diagram Model A

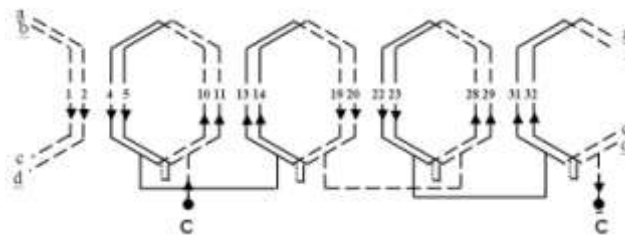

Fig. 5: Phase C winding diagram Model A

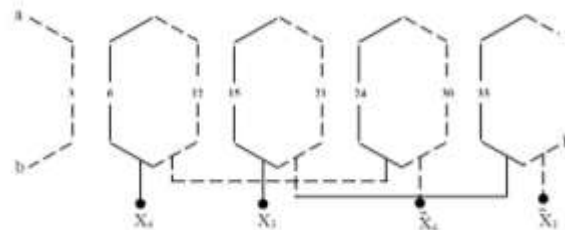

Fig. 6: X3, X4 winding diagram Model A

For the two models, the number of coils/pole/phase is equal to 3 coils for phase A and B (see Fig.s 3 and 4 for model A and Fig.s 7 and 8 for model B). While phase C has been left with 2 coils/pole/phase as shown in Fig. 5 for model A and Fig. 9 for model B. Four coils shown in Fig. 6 for model A and Fig. 10 for model B, have been connected in two groups named X_3 and X_4 . These may be used, as explained below, to produce two possible cases for each model.

Case 1: Symmetrical connection three-phase machine as shown in Fig.11 case 1.

Case 2: Asymmetrical windings connection; the coils X_3 and X_4 are connected to phase B as shown in Fig.11 case2.

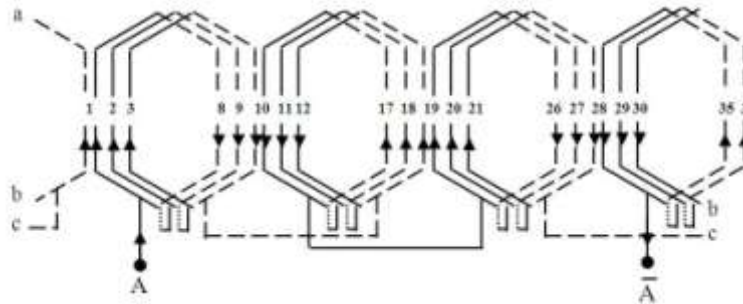

Fig. 7: phase A winding diagram for Model B

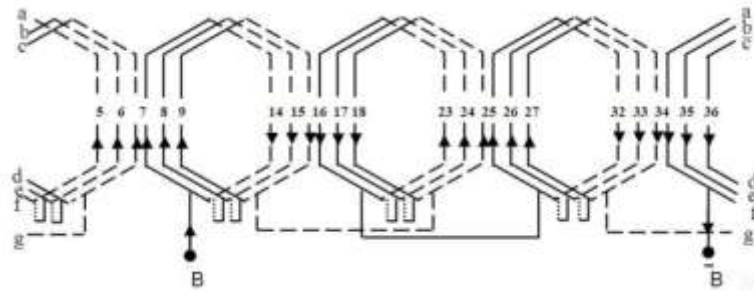

Fig. 8: Phase B winding diagram for Model B

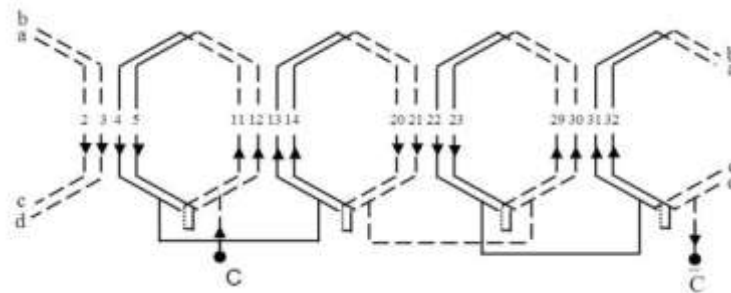

Fig. 9: Phase C winding diagram for Model B

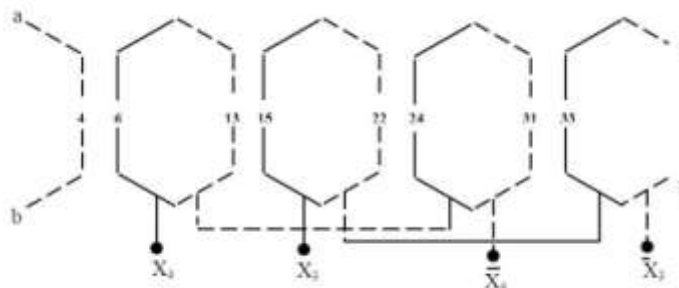

Fig. 10: X3 & X4 winding diagram for Model B

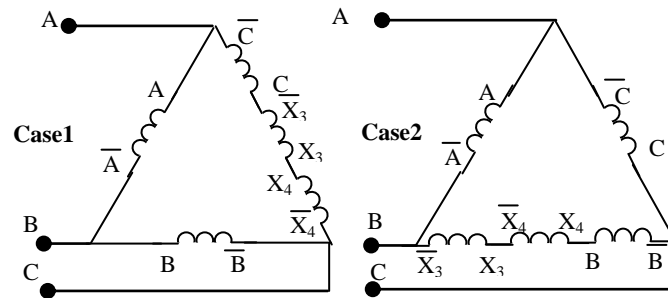

Fig. 11: Machine stator windings connections Case 1 symmetrical, Case 2 asymmetrical

Results:

The test machine was directly coupled to a D.C motor whose speed is controlled by means of Ward-Leonard arrangement. The torque on the stator was then measured at each required speed.

The test voltage has been limited to 50 volts, which corresponds to the maximum possible current rating of the wire used for the stator winding.

The theoretical and experimental results are plotted against the speed for the various cases, and can be seen in Fig. 12-20 for model A and in Fig.21-29 for model B.

A. Model A:

Fig.12 shows the torque/speed characteristic for case 1. It is clear that the correlation between the theoretical and experimental results is good.

The torque/speed characteristic is a smooth curve, as expected, since it represents the case of symmetrical windings. This could have been anticipated from the air-gap field harmonic analysis, which shows no predominant harmonics, as may be seen from Table II.

Figs.13-15 show respectively the variations of phase current with speed, line current with speed and phase angle with speed (with phase A as a reference). It is clear from these graphs that the motor draws balanced currents.

For case 2, the torque/speed, phase current/speed, line current/speed and phase angle/speed (with phase A as a reference) characteristics are given respectively in Figs.16-20. The predicted results may be seen to agree with experimental ones.

There are two dips in the torque/speed characteristic Fig.16 around 300 r.p.m. and 750 r.p.m. This may be attributed to the effect of 20-pole and 8-pole harmonic component as can be seen in Table III.

In this model in spite of, the connection being delta, the effect of zero-sequence (triplin harmonic) was not clear in the torque/speed characteristic and this may due to the fact that the coil span was equal to 2/3 pole pitch (Brown and Butler, 1954). In order to investigate that, model B was tested, with different chording.

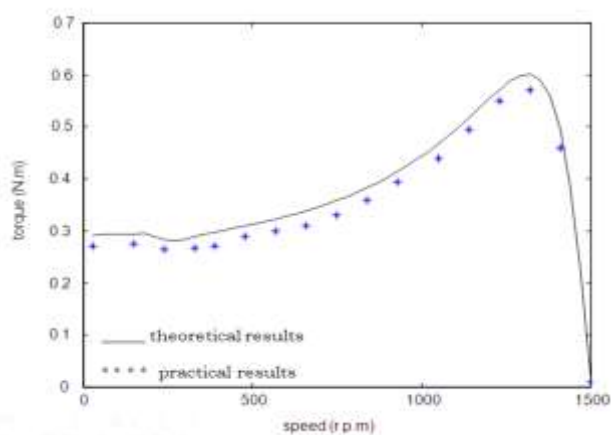

Fig. 12: Torque/Speed characteristic for case1 Model A

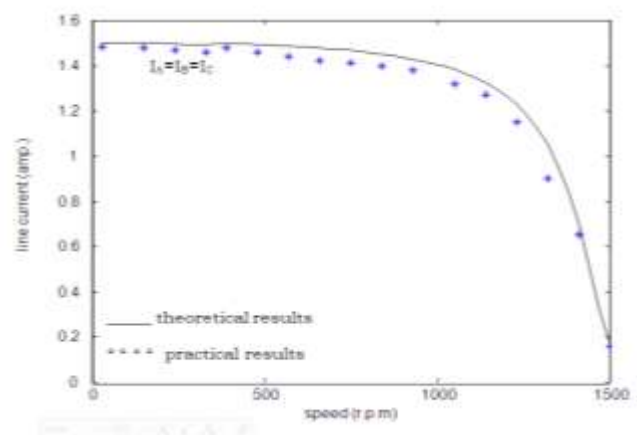

Fig. 13: Line current/Speed characteristic for case1 Model A

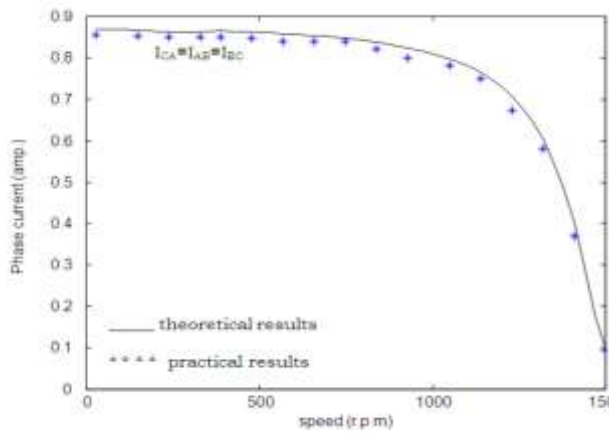

Fig. 14: Phase current/Speed characteristic for case1 Model A

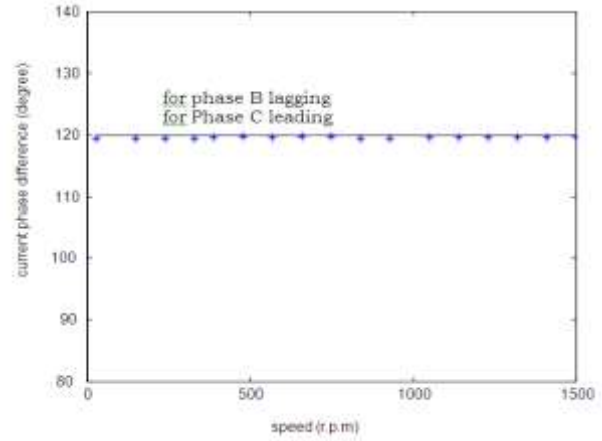

Fig. 15: Current phase difference with respect to phase A for case1 Model A

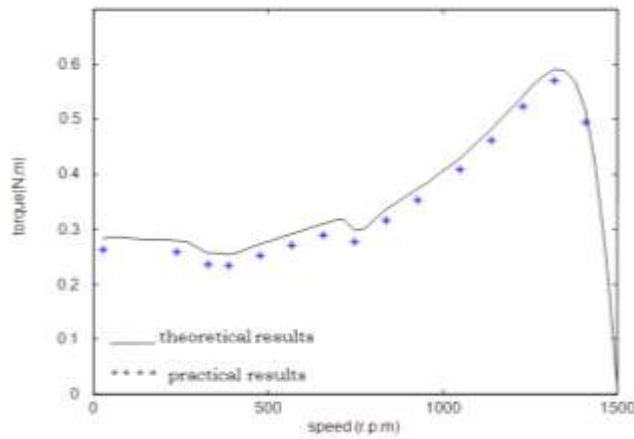

Fig. 16: Torque/Speed characteristic for case2 Model A

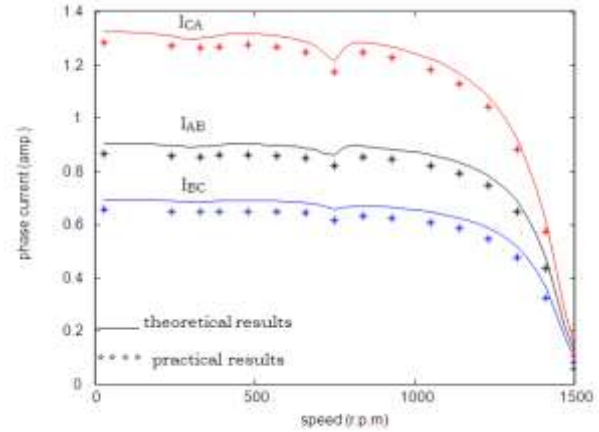

Fig. 17: Phase Currents/Speed characteristic for case2 Model A

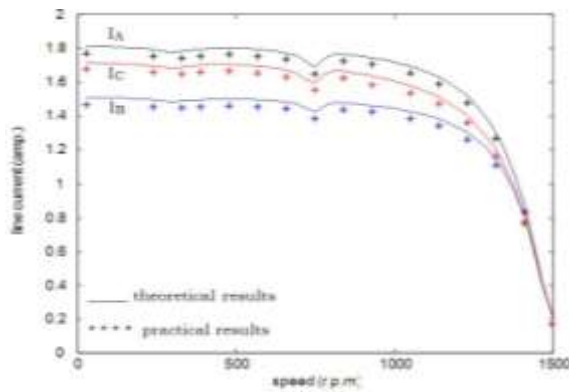

Fig. 18: Line currents/ Speed characteristic for case 2 Model A

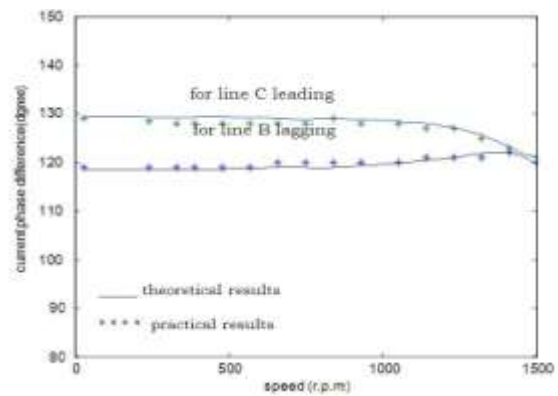

Fig. 19: Current phase difference with respect to phase A for case2 model A

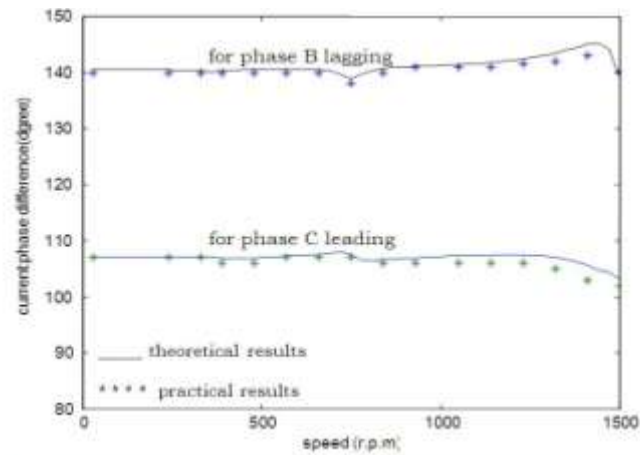

Fig. 20: Current phase difference with respect to line A for case 2 Model A

Table II: Harmonics of the air-gap field for symmetrical winding (case 1 model A) at 1425 r.p.m. ($s=0.05$).

N	Forward	Backward
2	117.8650 800°	
10		5.3436 -139.990°
14	3.1115 200°	
22		1.980 -48.210°
26	2.0552 -39.990°	
34		6.9332 100°

Table III: Harmonics of the air-gap field for asymmetrical winding (case 2 model A) at 1425 r.p.m. ($s=0.05$).

n	Forward	Backward	stationary
2	131.8841 64.520°	0.8382 -32.140°	4.6392 -111.09°
4	8.5572 7.070°	0.4191 -127.14°	2.3196 -131.09°
8	3.4229 147.070°	0.2095 -32.14°	0.9278 8.900°
0	4.2786 7.070°	0.3936 123.050°	1.1598 -11.090°
14	2.5671 44.810°	0.1197 -152.14°	0.6627 128.90°
16	2.1393 -112.92°	0.1048 67.85°	0.5799 108.90°
20	1.7114 27.070°	0.0838 -152.14°	0.4639 -111.09°
22	1.5559 -112.92°	0.0800 50.100°	0.4217 -131.09°
26	3.0915 -28.13°	0.0645 87.85°	0.3569 8.900°
28	1.2224 127.07°	0.0599 -52.14°	0.3314 -11.090°
32	1.0697 -92.92°	0.0524 87.85°	0.2899 128.90°
34	1.0067 127.07°	0.3799 30.39°	0.2729 108.90°

B. Model B:

Figs.21-24 show respectively the torque/speed, phase current/speed, line current/speed and phase angle/speed (with phase A as a reference) characteristics for symmetrical case. It is clear that there is no predominant harmonic, see Table IV.

Examining the torque/speed characteristic for the asymmetrical case 2 Fig.25 shows three dips around 375 r.p.m., 500 r.p.m. and 750 r.p.m. which may be attributed to the effect of 16-pole, 12-pole and 8-pole harmonic component. This should have been expected when examining the harmonic analysis as seen in Table V.

Fig.26 shows the variation of the unbalance phase currents with speed, Fig.27 shows the variation of the unbalanced line currents with speed.

Examining Table V, triplen harmonics (at $n=6, 12, 18, 24$ and 30 where n is the pole-pair harmonic order) exist which corresponds to the effect of zero-sequence and it can be seen from the mentioned table that the third harmonic is the predominant one, this corresponds dip around 500 r.p.m. on the torque/speed characteristic (see Fig.25).

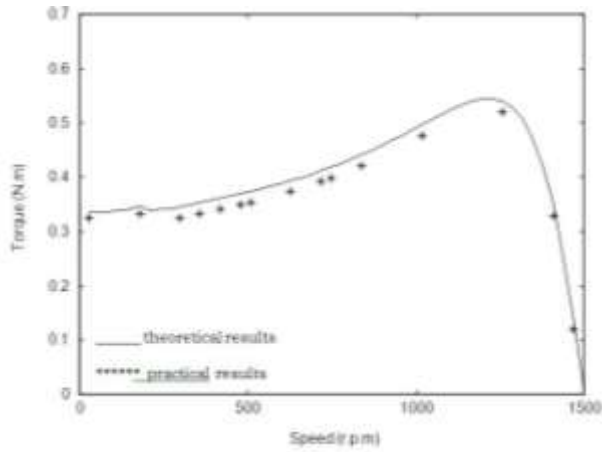

Fig. 21: Torque/speed characteristic for case1 Model B

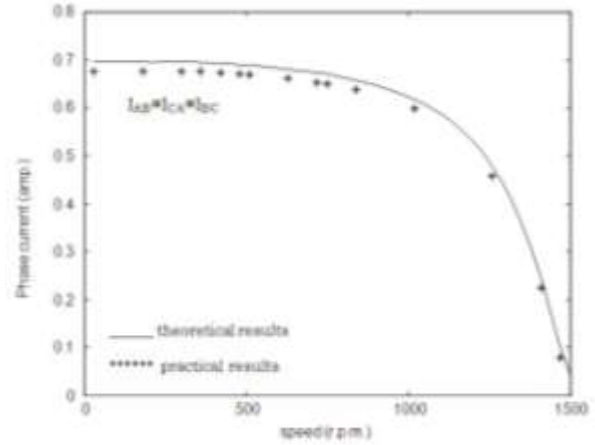

Fig. 22: Phase current/speed characteristic for case1 Model B

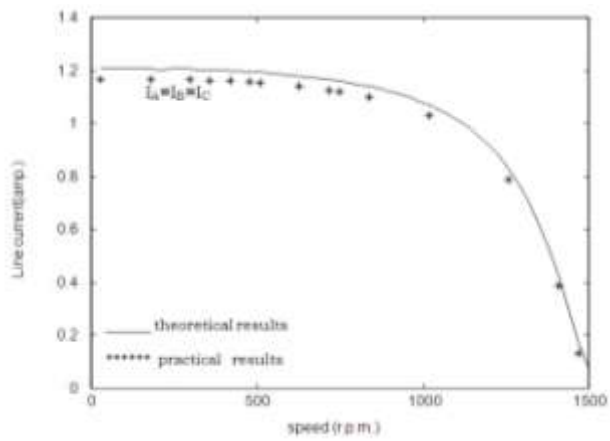

Fig. 23: Line current/speed characteristic for case1 Model B

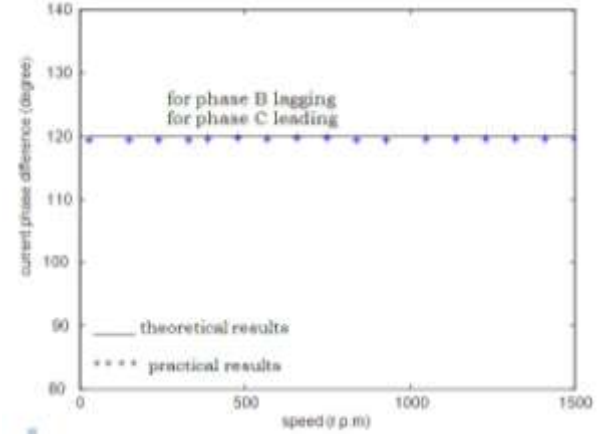

Fig. 24: Current phase difference with respect to phase A for case1 Model B

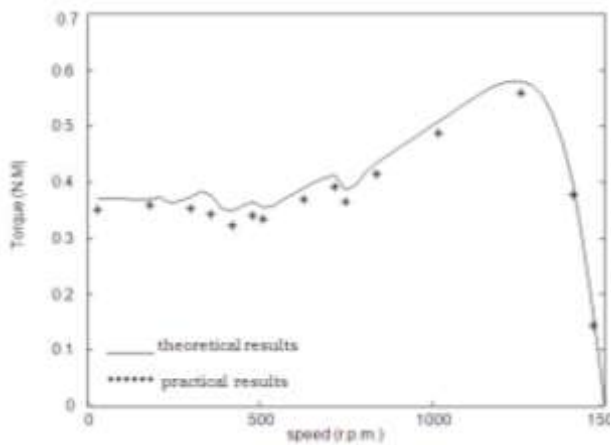

Fig. 25: Torque/speed characteristic for case2 Model B

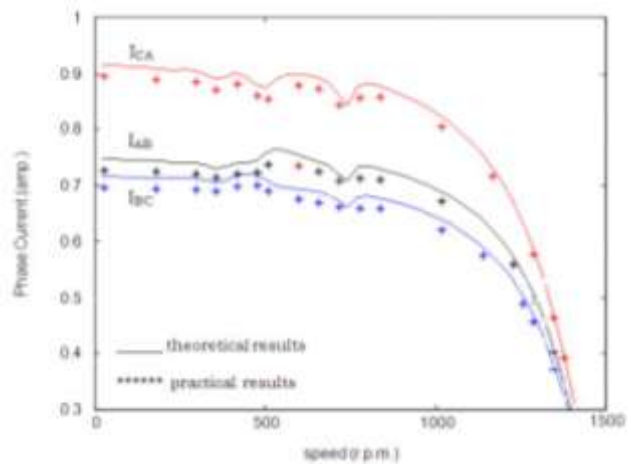

Fig. 26: Phase currents/speed characteristic for case2 Model B

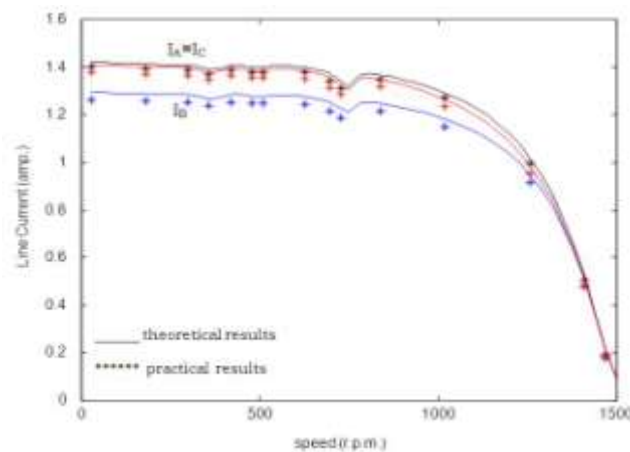

Fig. 27: Line currents/speed characteristic for case2 Model B

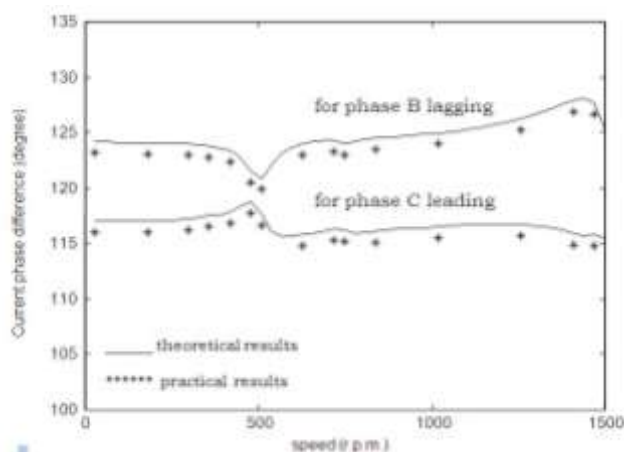

Fig. 28: Currents phase difference with respect to Phase A for case2 Model B

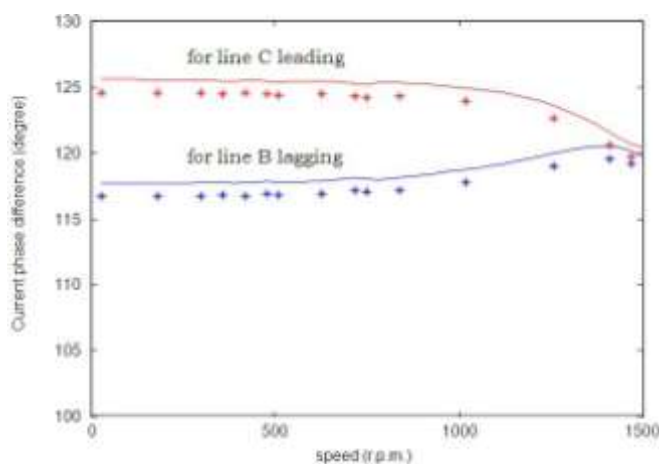

Fig. 29: Currents phase difference with respect to Line A for case2 Model B

Table IV: Harmonics of The Air-Gap Field for Symmetrical Winding (CASE 1 Model B) at 1425 r.p.m. (s=0.05).

N	Forward	Backward
2	73.0806 90°	
10		0.6123 -89.99°
14	1.5727 90°	
22		1.0008 90°
26	0.2355 -89.99°	
34		4.2989 90°

Table V: Harmonics of the air-gap field for asymmetrical winding (case 2 Model B) at 1425 r.p.m. (s=0.05).

N	Forward	Backward	Stationary
2	73.6702 82.9°	0.1988 -29.15°	0.9729 -85.19°
4	3.2697 35.45°	0.068 -159.14°	0.3328 -95.19°
6	1.6956 85.45°	0.0353 130.85°	0.9608 -174.14°
8	2.5047 -164.54°	0.0521 0.85°	0.2549 64.8°
10	0.3533 65.45°	0.0173 166.05°	0.036 54.8°
12	1.4684 -4.54°	0.0305 160.85°	0.1494 -135.19°
14	1.169 123.19°	0.0232 -89.14°	0.1133 -145.19°
16	0.4349 155.45°	0.009 -39.15°	0.0443 24.80°
18	1.1304 25.45°	0.0235 70.85°	0.2301 -165.19°
20	0.3480 135.44°	0.0072 -59.14°	0.0354 4.8°
22	0.7085 -174.54°	0.0155 -26.89°	0.0721 174.80°
24	0.7342 -64.54°	0.0153 100.85°	0.0747 164.80°
26	0.3191 -69.75°	0.0028 30.85°	0.0138 -25.19°
28	0.7156 95.45°	0.0149 -99.14°	0.0728 -35.19°
30	0.3391 -34.54°	0.0071 10.85°	0.1922 -156.2°
32	0.4087 -104.54°	0.0085 60.85°	0.0416 124.8°
34	0.5623 125.45°	0.0901 13.39°	0.0572 114.8°

Conclusion:

A method to predict the behavior of a Delta connected three phase induction motor with different three stator windings when connected to a balanced three phase supply system using revolving field theory and symmetrical component theory was presented in this paper.

The analysis presented is systematic and easy to be programmed by using computer.

From the classical theory we need only to calculate the stator and rotor resistances and their respective leakage reactances. And no additional parameters were needed.

The program is applicable when the supply is unbalance. Also, the zero sequence effect can be reduced, or accentuated by a proper choice of windings that is by making the coil pitch equals to the two third of the pole pitch as it is clear from the results of model A.

Appendix:

Winding distribution matrix

[Z]: is the winding distribution matrix; which is equal to the number of conductors (N) in a slot (m) for a phase (M) multiplied by the unit vector (Z_{mM}) with values +1, -1 and 0 to indicate current direction and existence.[13]

$$[Z] = \begin{matrix} & \begin{matrix} \text{Slo} & & & & & & \leftarrow \text{phases} \end{matrix} \\ \begin{matrix} \text{ts} \downarrow \\ a \\ b \\ \cdot \\ m \end{matrix} & \begin{bmatrix} & A & B & C & \\ Z_{aA}N_{aA} & Z_{aB}N_{aB} & Z_{aC}N_{aC} & \\ & Z_{bA}N_{bA} & Z_{bB}N_{bB} & Z_{bC}N_{bC} \\ & \cdot & \cdot & \cdot \\ Z_{mA}N_{mA} & Z_{mB}N_{mB} & Z_{mC}N_{mC} & \end{bmatrix} \end{matrix}$$

ACKNOWLEDGMENT

The authors are grateful to Baghdad University Engineering College workshop staff for considerable help during the construction of experimental models. Thanks are also due to the Baghdad University for financial support.

REFERENCES

- Al-MulaHumadi, R.M.K., 2001. Performance prediction of a delta connected three-phase induction motor with asymmetrical windings. M.Sc. Thesis, Dept. of electric Eng., Baghdad University, College of Engineering.
- Alwash, J.H.H and S.H. Ikhwan, 1995. Generalised approach to the analysis of asymmetrical three-phase induction motor. Proc. IEE Electr. Power Appl., 142(2): 87-96.
- Battersby, G.A., 1965. Analysis of asymmetrical induction- motor windings. Proc. IEE, 112(II): 2067-2073.
- Brown, J.E. and O.I. Butler, 1953. A General Method of Analysis of Three-Phase Induction Motors with Asymmetrical Primary Connections. Proc. IEE, 100(2): 25-34.
- Brown, J.E. and O.I. Butler, 1954. The zero-sequence parameters and performance of three phase induction motors. Proc. IEE, 101(IV): 219-224.
- Brown, J.E. and C.S. Jha, 1962. Generalised Rotating-Field Theory of Polyphase Induction Motors and Relationship to Symmetrical-Component Theory. Proc. IEE, 109(A): 59-69.
- Butler, O.I. and A.K. Wallace, 1968. Generalised Theory of Induction Motors with Asymmetrical Primary Windings," Proc. IEE, 115(5): 685-694.
- Faiz, J., H. Ebrahimpour and P. Pillay, 2004. Influence of unbalanced voltage on the steady state performance of a three-phase squirrel cage induction motor. IEEE Trans. Energy Conversion, 19(4): 657-662.
- Guru, B.S., 1979. Cross-field analysis of asymmetric three-phase induction motors, extension to single- and two-phase machines theoreof. IEEE Trans., PAS-98 (4): 1251-1258.
- Guru, B.S., 1979. Revolving-field analysis of asymmetric three-phase machines and its extension to single- and two-phase machines. IEE J. Electr. Power Appl., 2(1): 37-44.
- Guru, B.S., 1981. Analysis of induction motors with asymmetric windings. IEEE Trans., PAS-100(6): 3102-3109.
- Ikhwan, S.H., 1991. Analysis of asymmetrical three-phase induction motors. M.Sc. Thesis, Dept. of Electric Engineering, Baghdad University, College of Engineering.
- Jha, C.S and S.S. Murthy, 1973. Generalised Rotating-Field Theory of Wound-Rotor Induction Machines Having Asymmetry in The Stator and/or Rotor Windings. Proc. IEE, 120(8): 867-873.

Pillay, P., P. Hofmann and M. Manyage, 2002. Derating of induction motors operating with a combination of unbalanced voltages and over or under voltages. *IEEE Trans. Energy Conversion*, 17(4): 485-491.

Stepina, J., 1968. Fundamental equations of the space vector analysis of electrical machines. *Ada Tech. CSAV*(13): 184-198.

Stepina, J., 1979. Non-transformational matrix analysis of electrical machines. *Electr. Mach. Electromech.*, 4: 255-268.

Wang, Y.J., 2000. An analytical study on steady state performance of induction motor connected to unbalanced three-phase voltage. *IEEE Power Engineering Society, Winter Meeting, Singapore, Jan.:* 23-27.